

**ICON SERIES IDRIVE**  
**Intelligent Constant Pressure**  
**Water Supply Controller User Manual**  
**iDRIVE1150-240**



<b>CONTENTS</b>	
<b>PREFACE</b>	<b>3</b>
<b>1. PRODUCT DESCRIPTION</b>	<b>4</b>
1.1 Functions Description	4
1.2 Model List	4
1.3 Nameplate Description	4
1.4 External Dimension	5
<b>2. WIRING</b>	<b>5</b>
2.1 Main Circuit Terminals Wiring	5
2.2 Control Circuits Terminals Wiring	5
<b>3. OPERATION</b>	<b>7</b>
3.1 Keypad	7
3.2 Indicator Light	7
3.3 Key Function	8
3.4 Operation Process	8
<b>4. FUNCTIONING PARAMETER</b>	<b>9</b>
<b>5. TYPICAL APPLICATION CASE</b>	<b>16</b>
5.1 Single Pump Water Supply Application	16
5.1.1 System Wiring	16
5.1.2 Debugging	16
5.1.3 Relating Parameter Setting	17
5.2 Day-Part Water Supply Application	18
5.2.1 System Wiring	18
5.2.2 Typical Application	18
5.2.3 Parameter Settings	18
5.3 Terminal Run/Stop Control Wiring and Setting	19
5.3.1 System Wiring	19
5.3.2 Operation	19
5.3.3 Settings	20
5.4 Electric Contact Gauge Water Supply	20
5.4.1 System Wiring	20
5.4.2 Setting	20
5.5 Pumping Application	21
5.5.1 System Wiring	21
5.5.2 Example	21
5.5.3 Relating Parameter Setting	22
<b>5.6 Manual/Auto Control Application</b>	<b>22</b>
5.6.1 System Wiring	22
5.6.2 Setting	22
5.7 Summary	23
<b>6. FAULT AND TROUBLE SHOOTING</b>	<b>23</b>
<b>7. MAINTENANCE</b>	<b>23</b>
7.1 Daily Maintenance	24
7.2 Periodic Maintenance	24
7.3 Replacement Of Wearing Parts	24
<b>8. POSTSCRIPT</b>	<b>25</b>

## PREFACE

Thank you for choosing ICON iDRIVE.

With high quality, multi-functional, low noise and strong commonality etc. characteristics, iDRIVE series intelligent constant pressure water supply controller is suitable to full-automatic operation with components such as water detection use transducer, transmitter (include water level transmitter, temperature transmitter, etc.) or inductive remote transmission pressure gauge, its output is 4~20mA, 0~5VDC and 0~10 VDC Standard signal.

## SAFETY PRECAUTIONS

ISUB is a new power electronic product, please read the operation manual carefully before using to keep your safety and make sure proper operation.

In this manual, the safety precautions were sorted to "WARNING" and "CAUTION".



**WARNING:** Incorrect use may result in death or serious personal injury.



**CAUTION:** Incorrect use may result in the damage of controller or system.



### WARNING

- Do not dismantle or change the product, which may cause electric shock, fire hazard and personal injury.
- Do not open the cover during the running of controller. Disconnect power and allow 5 minutes for the internal capacitors to discharge dangerous internal voltage before working on controller and pump.
- Ensure that the controller along with the pump as well as metal in proximity are adequately earthed.
- Do not put wire, metal bar, filaments etc. into the controller as to cause a short circuit or get an electric shock.
- Do not splash water or other liquid over the controller.



### CAUTION

- The controller and pump should be installed by suitably qualified technical personnel, and failure to install in compliance with local standards may result in poor performance, equipment damage, fire and electrical shock.
- Do not perform high voltage insulation testing on the controller.
- Never connect AC power to output UVW terminals.
- The motor, controller and power specifications should be matching, otherwise it could cause abnormal operation and damage the equipment.
- If the controller has serious vibration, noise, heat or peculiar smell in the first operation, please cut off the power immediately and contact customer service.
- Do not install the controller in an environment with direct sunlight, rain, dust, frost or snow.

## 1. PRODUCT DESCRIPTION

### 1.1 Functions Description

Function Name	Action	Factory Setting
Sleep Function	No water consumption, pump decelerates to the lower limit and after a detection the controller sleeps down. When the pressure drops below settings, the controller will wake up automatically.	valid
Restarts After Power On	Power off during running, it restarts when power is on again.	invalid
Anti-clogging Function	Just designed for single pump, the pump run REV/FWD alternate.	invalid
Day-Part Control	Divide one day into several day-part to run a private pressure respectively. Considered input side water pressure limit, once input water pressure is less than setting pressure, stop running; while up to setting, recover running.	invalid
Terminal Run/Stop	Can be used with external switch from terminal. When switched on, pump runs at constant pressure; when off, pump stops.	invalid
Manual/Auto Control	Can be used with external switch from terminal. When switched on, pump runs at full frequency; when off, returns to variable frequency constant pressure control.	invalid
Electric Contact Control	Two terminals switch on COM and instruct the controller to accelerate and decelerate respectively. Can be used for pump running in a switch setting pressure range.	invalid

Warm reminder:

For convenience, the controller has set default with a nonzero AI1 Feedback Lost Detecting Value. If there hasn't been a pressure signal feedback into the terminal AI1, the controller will start up with failure and display "E022", connect a transducer to the controller and then press the **STOP/RST** key.

### 1.2 Model List

B601B Series Model List

Model No.	Rated Input Voltage (V)	Horse Power (HP)	Rated Output Current (A)	Motor Power (kW)
B601B-2001	1AC:240V -15%~+15%	1.0	5.3	0.75
B601B-20015		1.5	6.5	1.1
B601B-2002		2.0	9.6	1.5
B601B-2003		3.0	14	2.2

### 1.3 Nameplate Description

B601B - 2001

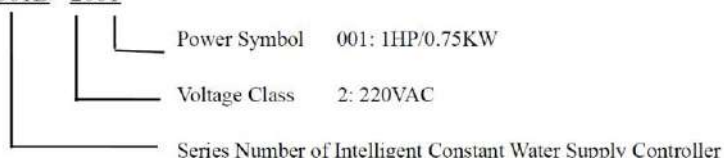

### 1.4 External Dimensions

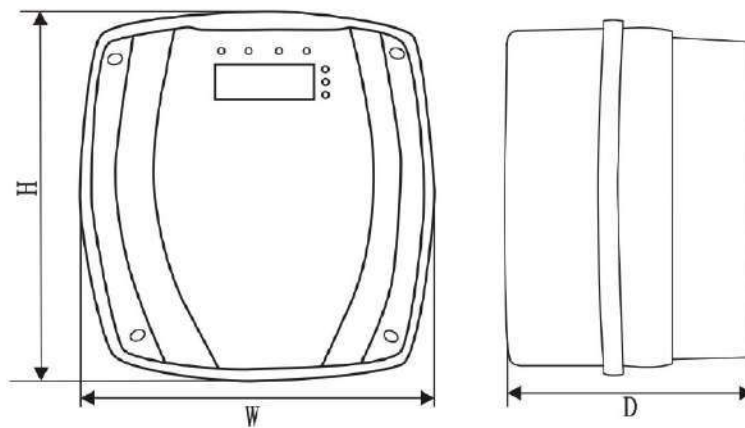
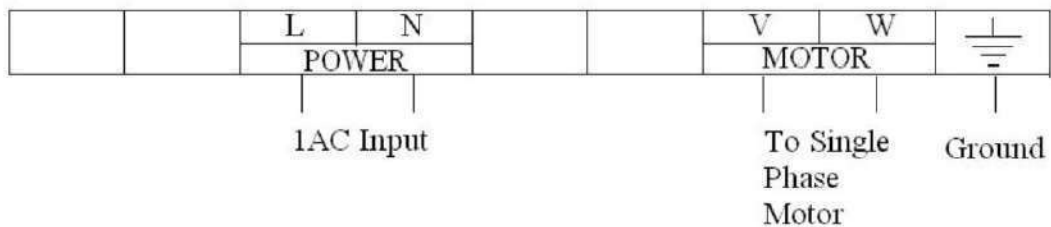

Figure 1-4 Dimension of 601B

Model (KW)	A(mm)	B (mm)	H (mm)	W (mm)	D (mm)	Installation Hole
	Installation Dimension		External Dimension			
0.75~1.5	-	-	192	200	151	-
2.2	-	-	282	255	160	-

## 2. WIRING

### 2.1 Main Circuit Terminal Wiring



### 2.2 Control Circuits Terminal Wiring

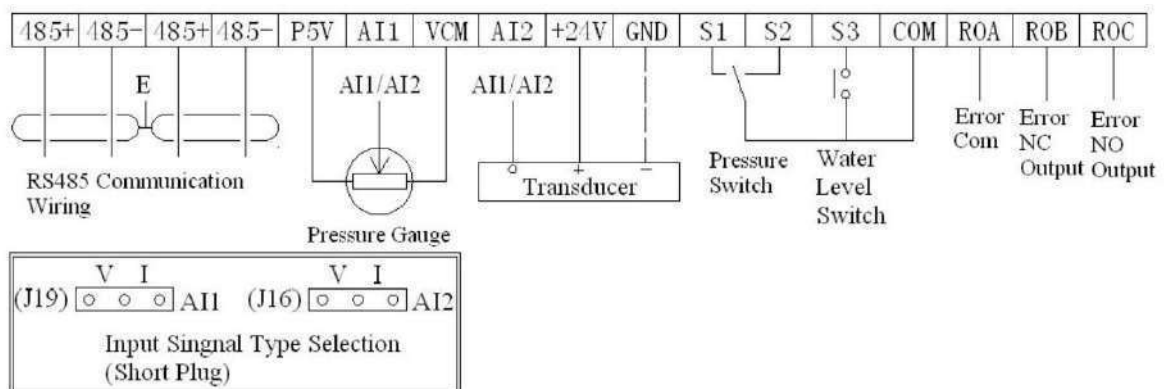

Function Terminals Wiring and Description.

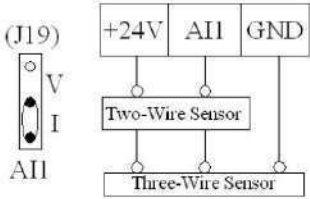
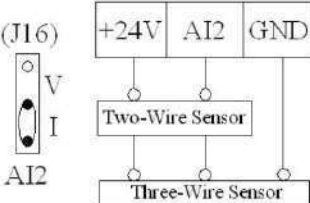
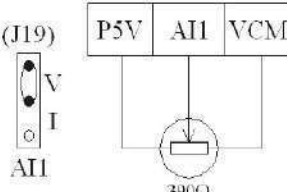
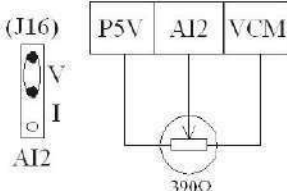
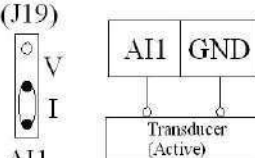
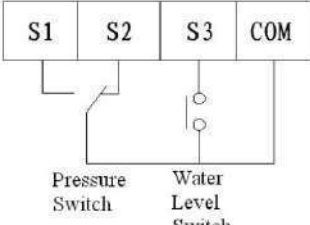
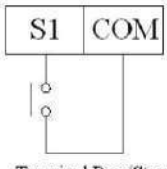
Wiring	Description
	<p><b>Outlet Pressure Transmitter Wiring</b> The pump outlet feedback pressure signal (4~20mA), can use the 2-wire or 3-wire transducer to generate.</p>
	<p><b>Inlet Pressure Transmitter Wiring</b> The pump outlet feedback pressure signal (4~20mA), can use the 2-wire or 3-wire transducer to generate.</p>
	<p><b>Outlet Pressure Transmitter Wiring</b> The pump inlet feedback pressure signal (1~5V), can use transmissible pressure gauge to generate.</p>
	<p><b>Inlet Pressure Transmitter Wiring</b> The pump inlet feedback pressure signal (1~5V), can use transmissible pressure gauge to generate.</p>
	<p><b>Transmissible Pressure Gauge Wiring</b> Apply to water level (pumping) or temperature (refrigeration) control, when AI1 is set as 0~100% input, the corresponding current range is 4~20mA.</p>
	<p><b>Water Level Switch and Electric Contact Pressure Gauge Wiring</b>  <u>S1</u>-<u>COM</u> on: Acceleration  <u>S2</u>-<u>COM</u> off: Deceleration  <u>S3</u>-<u>COM</u> on: Low Level alarm, NO or NC operation mode can be choose</p>
	<p><b>Terminal Run/Stop Control Wiring</b>  <u>S1</u>-<u>COM</u> on: Run  <u>S1</u>-<u>COM</u> off: Stop</p>

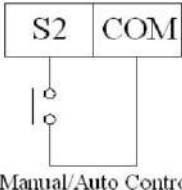
Wiring	Description
 <p>Manual/Auto Control</p>	<p><b>Manual/Auto Control Wiring</b></p> <p><b>S2</b>-<b>COM</b> on: Manual control  <b>S2</b>-<b>COM</b> off: Auto control</p>

### 3. OPERATION

#### 3.1 Keypad

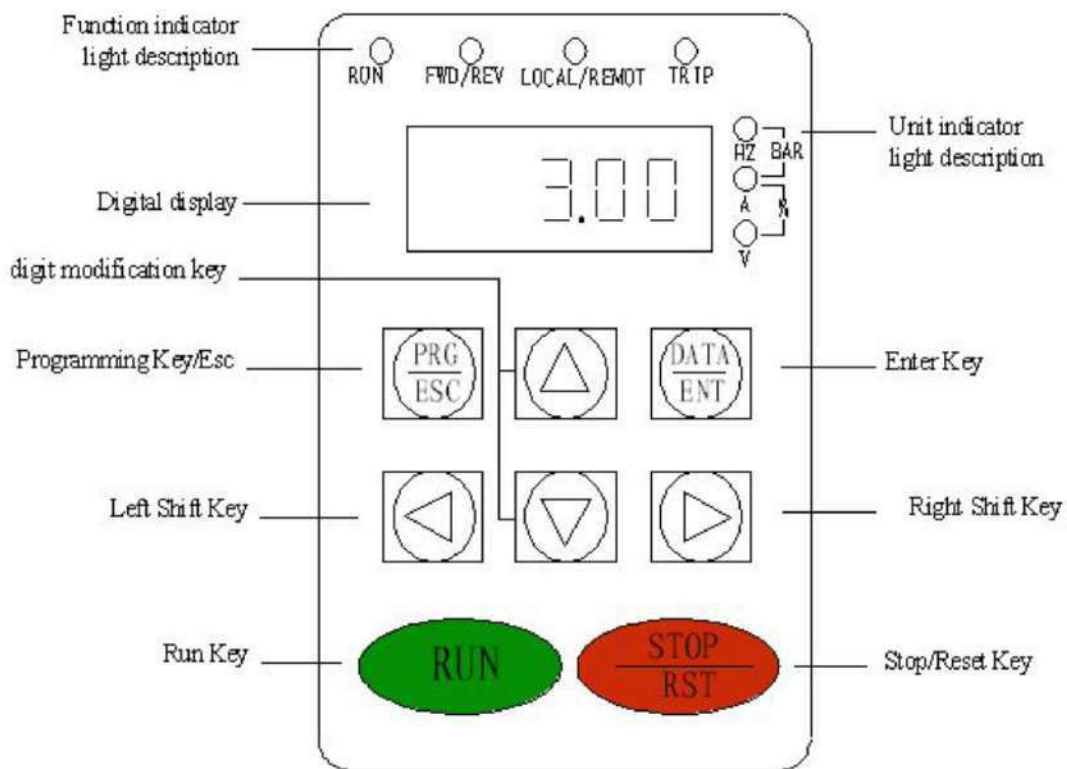









Figure3.1 Keypad schematic diagram

#### 3.2 Indicator Light

NAME	Description
<b>RUN</b>	Extinguished: stop status; Light on: operating status
<b>FWD/REV</b>	Extinguished: forward operation; Light on: reverse operation
<b>LOCAL/REMOT</b>	Extinguished: master controller; Light on: auxiliary controller
<b>TRIP</b>	Extinguished: normal operation status; Light on: fault status
<b>Hz</b>	Frequency unit, flickering or light on when display frequency
<b>A</b>	Current unit, light on when display current
<b>V</b>	Voltage unit, light on when display voltage
<b>BAR</b>	Pressure unit , 2 lights on or flickering
<b>%</b>	Percentage unit, 2 lights on
Digital display	5 digit LED display, monitoring all kinds of data and alarm codes



### 3.3 Key Function

Button	Name	Function
	Programming Key/ESC	Enter or exit from first-level menu.
	Enter Key	Progressively enter menu and confirm parameters.
	UP Increment Key	Progressively increase data or function codes
	DOWN Decrement Key	Progressively decrease data or function codes.
	Left Shift Key	In parameter setting mode, press one of these two buttons to select the bit to be modified. In other modes, cyclically display parameters by left/right shift.
	Right Shift Key	
	Run Key	Start running the controller.
	Stop/Reset Key	In running status, it can be used to stop the controller. When fault alarm, it can be used to reset the controller.

### 3.4 Operation Process

Power-On Initialization: Firstly the system initializes during the controller power-on, and LED displays “B-601”. After the initialization is completed, the controller is on stand-by status.





Parameter Setting: Three levels of menu are Function code group (first-level), Function code (second-level) and Function code value (third-level).

At the primary interface, press  or  will switch-over display running/stop status monitoring parameters. And press PRG/ESC will enter the first-level menu. In first-level menu press PRG/ESC will return to the primary interface, and if press DATA/ENT, enter the second-level menu. In second-level menu can also press PRG/ESC and DATA/ENT return to first-level menu or enter third-level menu.

Press both the PRG/ESC and DATA/ENT can return to the second-level menu from the third-level menu. The difference is: pressing DATA/ENT will save the parameters into the control panel, and then return to the second-level menu with shifting to the next function code automatically; while pressing PRG/ESC will directly return to the second-level menu without saving the parameters, and keep staying at the current function code.

**Example 1:** Change factory pressure setting 3.0 bar to 2.5 bar

**Method 1:** Adjust at the primary interface

At the primary interface, press  or  the LED turns to display setting pressure value automatically. To press  or  again, pressure setting value will be increase/decrease 0.1, meanwhile pump follows the setting pressure value automatically.

Attention, if without pressing DATA/ENT to store the adjusted pressure value into b00.01, when powered on again, the machine running with the origin setting pressure of b00.01 that unadjusted.

**Method 2:** Set into the parameter, follow is the operation process diagram.



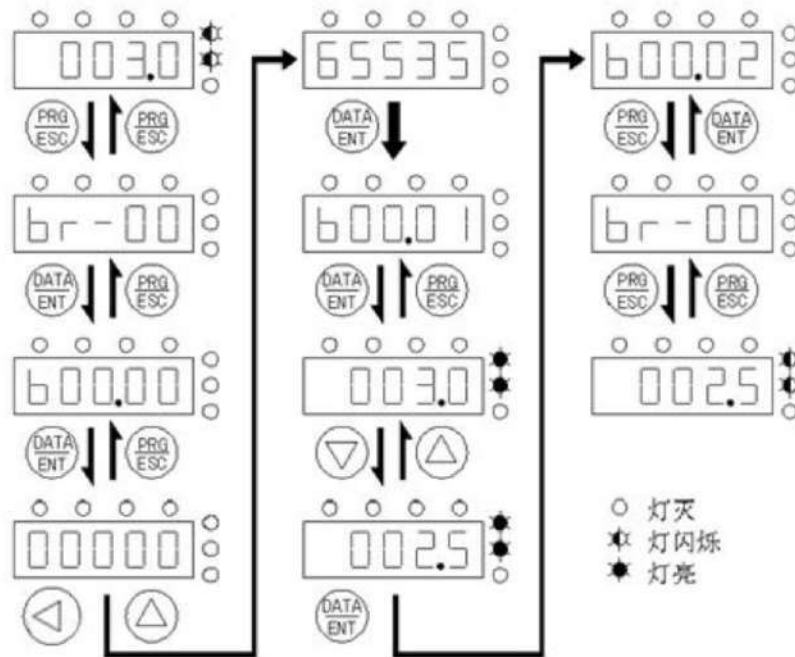

Figure 3-4-1 Operation Process Diagram

**Example 2:** During the running of the controller, press or to scroll through the parameters in left or right order until there is two upper lights on, can check the feedback pressure value.

#### 4. FUNCTIONING PARAMETER

Entering b00.00 requires password, Factory default: 65535, input the password and access to debugging parameter group.

Function Code	Name	Setting Range	Factory Setting	Description
<b>Group br00 Application Group</b>				
b00.00	Debugging password	0~65535	00000	Parameter group password, can be changed by b06.09, default is 65535
b00.01	Pressure setting value	0.0~100.0	3.0bar	Set according to the actual requirements of user
b00.02	Motor rotating direction	0,1	0	0: forward 1: reverse
b00.03	Reserved			
b00.04	Anti-clogging	0,1	0	0: invalid 1: valid Prevention measures, auto reset after stop the running pump.
b00.05	Anti-clogging rotating cycle	0.0~300.0 s	0.0	When the anti-clogging function is valid, used to set the forward/reverse rotating direction cycle and corresponding output frequency (frequency setting value should be lower than the rated frequency of the pump so as not to cause damage)
b00.06	Anti-clogging output frequency	0.00~600.00HZ	30.00Hz	

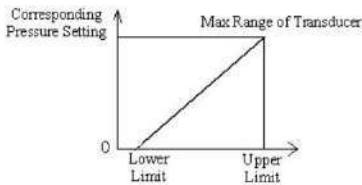
Function Code	Name	Setting Range	Factory Setting	Description	
<b>Group br01 Running Parameter Group</b>					
b01.00	High Water Pressure/Level Alarm Value	0.0~100.0	10.0bar	When pressure is higher than this preset value, the pump halts, alarms and displays HP.	
b01.01	Low Water Pressure/Level Alarm Value	0.0~100.0 bar	0.5bar	When pressure is lower than the preset value for a Low Pressure Running Time, the pump halts, alarms and displaying LP.	
b01.02	Low Pressure/Level Running Time	0~60s	10s		
b01.03	Reserved				
B01.04	Anti-clogging FWD./REV. Dead Time	0.0~3600.0	1.0s	When anti-clogging is valid, b01.04 set the FWD./REV. transition time	
b01.05	Maximum Transducer Setting Range	0.0~100.0	10.0	E.g. If the rated max. range of transducer is 10Bar, b01.05 should be set to 10.0	
b01.06	All Lower Limit	0.00~10.00V	0.00V	<ul style="list-style-type: none"> <li>Lower limit use to Transducer Zero Setting(When is currents input, 4~20mA corresponds 1~5V)</li> <li>Higher limit use to accordant display and gauge pointing. When display smaller than gauge, decrease higher limit(b01.08);</li> <li>When display bigger than gauge, increase higher limit(b01.08).</li> <li>When analog input is interfered, prolong Filtering time so as to increase the ability of anti-interference, but decrease the sensitivity.</li> <li>Corresponding relationship of Transducer Parameter Setting:</li> </ul> 	
b01.07	Corresponding Setting of All Lower Limit	-100~100%	0%		
b01.08	All Higher Limit	0~10V	5V		
b01.09	Corresponding Setting of All Higher Limit	-100~100%	100%		
b01.10	All Filtering time	0.00~10.00s	0.10s		
b01.11	AI2 Lower Limit	0~10V	0V		
b01.12	Corresponding Setting of AI2 Lower Limit	-100~100%	0%		
b01.13	AI2 Higher Limit	0~10V	5V		
b01.14	Corresponding Setting of AI2 Higher Limit	-100~100%	100%		
b01.15	AI2 Filtering time	0.00~10.00s	0.10s		Figure4-1-1 Transducer Parameters
b01.16	Restart After Power-on	0,1	0		0:invalid 1:valid
b01.17	Control mode	0,1	0		0:synchronous 1:master-slave

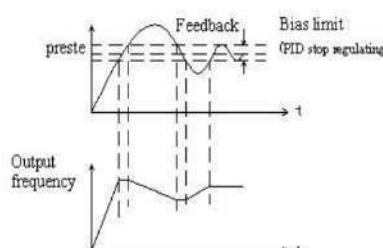
Function Code	Name	Setting Range	Factory Setting	Description
<b>GROUP br02 PID PARAMETER GROUP</b>				
b02.00	PID Source Selection	0,1	0	0:Keypad 1: Communication
b02.01	PID Feedback Source Selection	0~2	0	0:AI1 1:communication 2:Reserved
b02.02	PID Output Characteristics	0,1	0	0:water Supply 1:pumping
b02.03	Proportional Gain (Kp)	0.00~100.00	0.60	Determining the strength of PID regulation, Kp is bigger, regulation is stronger, but fluctuate easier too.
b02.04	Integral Time (Ti)	0.01~10	0.30s	Bias between the Feedback and the Given, determining the speed of regulation, a shorter Ti gains a stronger regulation.
b02.05	Differential Time (Td)	0.00~10	0.00s	Variable Ratio between the Feedback and the Given, a longer Td gives a stronger regulation. Be cautious use, for differential regulation amplifies interference of system.
b02.06	Sampling Cycle (T)	0.01~100.00	0.10s	Calculating time of regulator, when increased, response sluggishly.
b02.07	PID Control Bias Limit	0.0~100%	0.00%	<p>Max. Bias of PID output value corresponding to closed loop given value; Corresponding System Diagram of Max. Limit and Output Frequency.</p>  <p>Figure4-2-1 PID control curve Properly set the value can regulate the accuracy and stability of PID system.</p>
b02.08	AI1 Feedback Lost Detecting Value	0.0~100.0 %	1.0%	Transducer Fault Detecting Setting Value, corresponding to full range(100%), when the detecting time exceeds Feedback Lost time, it is deemed as malfunction by Transducer, the system will report E022 as Transducer Fault Code
b02.09	AI2 Feedback Lost Detecting Value	0.0~100.0 %	0.0%	
b02.10	Feedback Lost Detecting time	0.00~3600s	1.00s	

<b>Group br03 Communication Parameter Group</b>				
Multi-pump control temporary reserved, do not modify this group.				
<b>Group br04 Sleeping Function Group</b>				
b04.00	Sleeping Function	0,1	1	No consuming auto stop. 0:invalid 1:valid
b04.01	Sleeping Waiting time	0.0~300.0s	5.0s	delay time, seconds unit
b04.02	Sleeping Test Freq. proportion	0~100%	4%	Ensure Halt frequency when no consuming, the value corresponds the rated frequency, e.g. rated frequency50Hz×4%=2Hz, spot setting 1%~4% as proper.
b04.03	Wake-up Pressure Bias	0.0~20.0bar	0.5bar	During sleeping waiting time, when the practical outlet pressure is lower than the setting pressure, that is, b00.00 subtracts Wake-up Pressure Bias, the pump restart to work automatically, e.g. the setting value(L)=3.0Bar, Bias(b04.03)=0.5bar, Practical pressure(P)≤L-0.5=2.5bar, the pump will restart to work automatically again.
<b>Group br05 Control Parameter Group</b>				
b05.00	Water Level Control (Terminal S3)	0~2	1	Water level switch style, 0: invalid 1: NC 2: NO
b05.01	S3 Action Delay Time	0~300min	0	Delay time after level switch on, the time can not be set shortly or will create fluctuation caused by frequent initiate-stop.
b05.02	Terminal S1S2 Control	0~3	0	0: invalid 1: Electric contact control S1-COM on: Frequency rise S2-COM on: Frequency drop 2: Manual/auto control S2-COM off: auto control S2-COM on: manual control 3: Terminal run/stop S1-COM on: Run S1-COM off: Stop S2-COM off: auto control S2-COM on: manual control Auto Control: Constant water pressure control Manual Control: Full frequency Running
b05.03	Acceleration Time	0.1~3600s	Model set	The setting time from max. Frequency to zero.
b05.04	Deceleration Time	0.1~3600s	Model set	The setting time from zero to max. Frequency
b05.05	Maximum Output Frequency	10.00~60.00Hz	50.00Hz	Determine the Acc./Dec. rate

b05.06	Up limit of Output Frequency	00.00~b05.05 (Max. Frequency)	50.00Hz	Maximum running frequency
b05.07	Lower Limit of Output Frequency	0.00~600.00Hz	30.00Hz	The setting in order to guarantee High Efficiency of water pump, depend on the features of the pump, advise that the setting value is selected from 30.00Hz to 40.00Hz.
b05.08	Carrier Frequency	1.0~15.0k Hz	Model Set	Use to ameliorate the noise of motor and controller's interference to the surroundings. A high carrier makes a low motor noise, but leads to a big temperature rise and interference. Should not be altered if unnecessary.
b05.09	Low Pressure(LP) Restart Delay Time	0.0~300.0 min	0.0	In case of Low Pressure, BR5.09≠0,the controller restart to work according to the setting time automatically, without artificial restart. BR5.09=0, means auto restart invalid.
b05.10	Alternating Time 0.0:invalid	0.0~600.0 h	0.0	In order to balance and prolong the pump service life to set the parameter, Unit: hour, when the parameter is set to 0.0, it means in-execution. Operational time of master and auxiliary pump switches over according to the setting Alternating Time.
<b>Group br06 Interface Parameter Group</b>				
b06.00	Running Status Display Selection	0~0x1FF	0x01F	bit0: Operational Frequency bit1: Pressure tested value bit2: Pressure setting value bit3: Output Current bit4:Busbar Voltage bit5:Output Voltage bit6:Present Time bit7: Inlet Pump Pressure bit8: Master Sending Frequency
b06.01	Stop Status Display Selection	0~0x1FF	0x00F	bit0: Pressure setting value bit1: Pressure tested value bit2: Setting Frequency bit3: Busbar Voltage bit4: Input Terminal Status bit5:Output Terminal Status bit6:All Input Voltage bit7: Inlet Pump Pressure bit8: Present Time

b06.02	Keypad Display Selection	0~3	0	0:External Keypad Prior Enable 1:Both Display Enable, Only External Keypad Control; 2:Both Display Enable, Only Onboard Keypad Control; 3:Both Display Enable and Keypad Control.
b06.03	Relay Output Selection	0~4	0	0:Error or External Fault 1:Forward Running 2:Frequency Reaching 3:Stop Status 4:Lower Limit of Output Frequency Reaching
b06.04	Third Latest Fault Type		Read Only	E000:Fault-free E001:INU U phase protection E002:INU V phase protection E003:INU W phase protection E004:Acceleration OC E005:Deceleration OC E006:Constant Velocity OC E007:Acceleration OV E008:Deceleration OV E009:Constant Velocity OV E010:Busbar Under voltage E011:Motor Overload E012:Controller Overload E013:Input Phase Failure E014:Output Phase Failure E015:Rectifier Module Overheat E016:Inversion Module Overheat E017:Outside Fault E018:Communication Fault E019:Current Sense Fault E020: Reserve E021:EEPROM Operation Fault E022:Transducer Fault E023:Reserve E024:Reserve
b06.05	Second Latest Fault Type			
b06.06	Latest Fault Type			
b06.07	Parameters Storage Condition	0~2		
b06.08	Accumulated Running Time	0~65535h	Read Only	Display Accumulated Running Time
b06.09	Set the Password of br00.06	0~65535	65535	Password set prevent user from modifying the parameters randomly, avoiding running abnormally and damages.
<b>Group br07 Day-part Water Supply Parameter Group</b>				

b07.00	Day-part Function Selection	0~3	0	0:invalid 1:day-part A 2:day-part A and B 3:day-part A, B, C
b07.01	Day-part A Starting Time	00.00~24.00	0	<ul style="list-style-type: none"> <li>●Setting Starting Time and Finishing Time to 0 is invalid.</li> <li>●Pressure Setting determines the steady state value of outlet pressure.</li> <li>●Once actual pressure from inlet pipe network lower than setting lower limit pressure value such as b07.04, the pump stops till it rise up to lower limit pressure value again.</li> <li>●When regardless of the inlet water pressure, just set the lower limit as 0.</li> </ul>
b07.02	Day-part A Pressure Setting	0~20bar	3.0bar	
b07.03	Day-part A Finishing Time	00.00~24.00	0	
b07.04	AI2 Lower Limit of Day-part A	0~20bar	2.0bar	
b07.05	Day-part B Starting Time	00.01~24.00	0	
b07.06	Day-part B Pressure Setting	0~20bar	3.0bar	
b07.07	Day-part B Finishing Time	00.00~24.00	0	
b07.08	AI2 Lower Limit of Day-part B	0~20bar	3.0bar	
b07.09	Day-part C Starting Time	00.00~24.00	0	
b07.10	Day-part C Pressure Setting	0~20bar	3.0bar	
b07.11	Day-part C Finishing Time	00.00~24.00	0	
b07.12	AI2 Lower Limit of Day-part C	0.0~20.0bar	3.0bar	
b07.13	Lower Limit of Inlet Pressure	0~20bar	0.0bar	
b07.14	Restore Defaults	0~2	0	0:No action 1:Set to default 2:Clear error records
b07.15	Password of Group br08	0~65535	00000	Decide by b08.06, default of b08.06 is 65535.
<b>Group br08 Motor Parameter Group</b>				
b08.00	G/P Option	0,1	0	0:G model 1:P model
b08.01	Motor Rated Power	0.4~93kw	Model Set	Setting parameters according to nameplate of Motor. The controller's OV, OC protection

b08.02	Motor Rated Frequency	0.01~600 Hz	50Hz	
b08.03	Motor Rated Speed	0~36000 RPM	Model Set	
b08.04	Motor Rated Voltage	0~460V		
b08.05	Motor Rated Current	0.1~2000 A		
b08.06	Password of br07.15	0~65535	65535	Modify password of BR7.15
b08.07	Password of Factory Parameters	0~65535	xxxxx	Don't have a try or will cause abnormal operation and damages.

## 5. TYPICAL APPLICATION CASE

### 5.1 Single Pump Water Supply Application

#### 5.1.1 System Wiring

In Diagram : ① B601B Intelligent Controller; ② Pumps Group; ③ Pressure Tank; ④ None-return Valve; ⑤ Pressure Transducer; ⑥ Level Switch (to pool); ⑦ Fault Indicator; ⑧ Power Supply Indicator; ⑨ Fuse; ⑩ Breaker.

Faults and running indication will require ⑦⑧⑨.

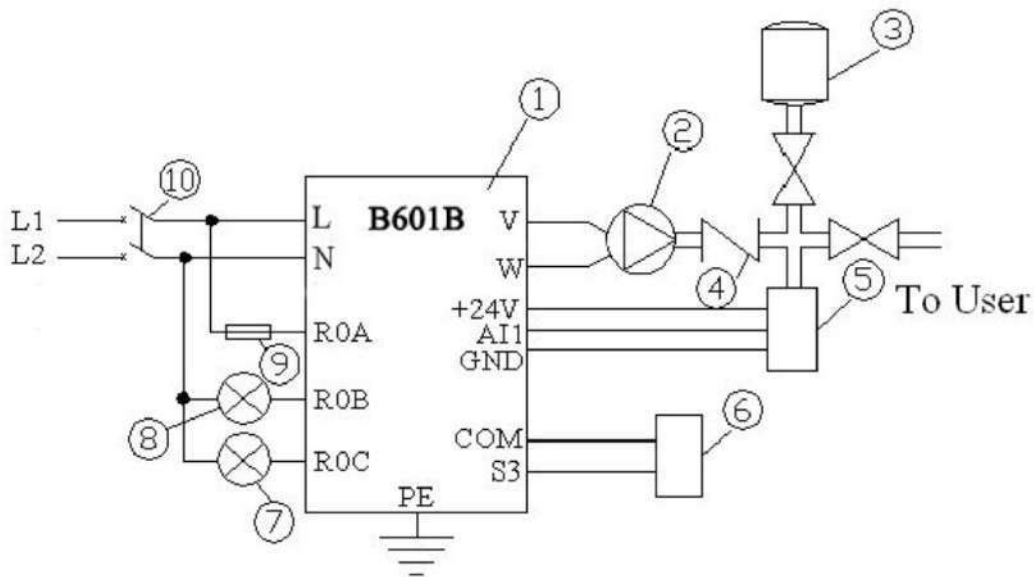

Figure5-1-1 Single Pump Wiring Addition Failure Indication

#### 5.1.2 Debugging

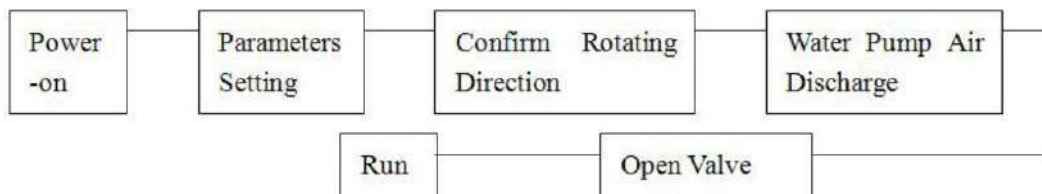

Figure5-1-2 Debugging Flow Diagram





## 5.2 Day-Part Water Supply Application

### 5.2.1 System Wiring

In diagram: ① B601B controller ② Pumps ③ Air Pressure Tank

④ Water Inlet Transducer ⑤ Water Outlet Transducer

⑥ Level Control Switch (Use in no negative pressure water supply)

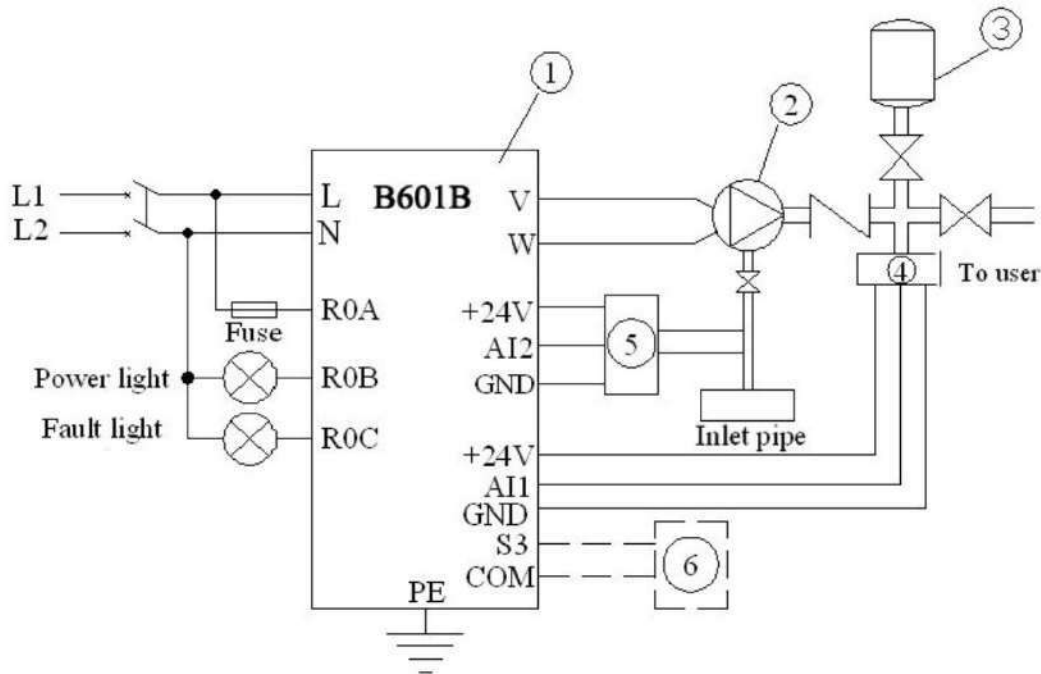

Figure5-2- 1 Day-part water supply wiring

### 5.2.2 Typical Application

Use in pipe pressure lamination, no negative pressure water supply, pipe network add-pressure to up level tank water supply, etc.

For example, make the first part running a 2.5bar pressure from 00:00 to 06:00, stop running as water inlet pressure below 2.0bar; Second part running a 3.2bar pressure from 06:00 to 13:30, stop running when inlet pressure below 2.3bar; Third part running a 3.5bar pressure from 17:00 to 23:00, stop running when inlet pressure below 2.2bar. The undefined day part running a 3.0bar, stop running when inlet pressure below 1.8bar.

### 5.2.3 Parameter Settings

Follow section 5.1 to set other parameters first, and then refer to this application to set day-part control parameters.

Day-part water supply parameter setting:

Code	Factory Setting	Recom mend	Description
b01.11 b01.13			Inlet transducer calibration(b01.11,b01.13), if needn't detect inlet pressure, no need to install inlet transducer and calibration, but the inlet pressure lower limit of every day-part set as 0 is needed.
b07.00	0	3	Day-part number setting, 0 means day-part control invalid, we now choose 3 day-part.

Code	Factory Setting	Recom mend	Description
b07.01	00.00	00.00	Set 00:00~06:00 running with 2.5bar, stop when inlet pressure below 2.0bar. (It recovers running when inlet pressure return to 2.0bar again)
b07.02	3.0	2.5	
b07.03	00.00	06.00	
b07.04	2.0	2.0	
b07.05	00.00	06.00	Set 06:00~13:30 running with 3.2bar, stop when inlet pressure below 2.3bar.
b07.06	3.0	3.2	
b07.07	00.00	13.50	
b07.08	2.0	2.3	
b07.09	00.00	17.00	Set 17:00~23:00 running with 3.5bar, stop when inlet pressure below 2.2bar.
b07.10	3.0	3.5	
b07.11	00.00	23.00	
b07.12	2.0	2.2	
b07.13	0.0	1.8	Set running with 3.0bar in the time-slot undefined, stop when inlet pressure below 1.8bar.
b00.01	3.0	3.0	

### 5.3 Terminal Run/Stop Control Wiring and Setting

#### 5.3.1 System Wiring

Base on above applications, connect a switch to S1-COM refers to section 2.2 **Terminal Run/Stop Control Wiring.**

In diagram: ① B601B intelligent controller; ② Pumps; ③ Air Pressure Tank; ④ Outlet Transducer; ⑤ Inlet Transducer; ⑥ Water Level Switch; ⑦ External Run/Stop Switch.

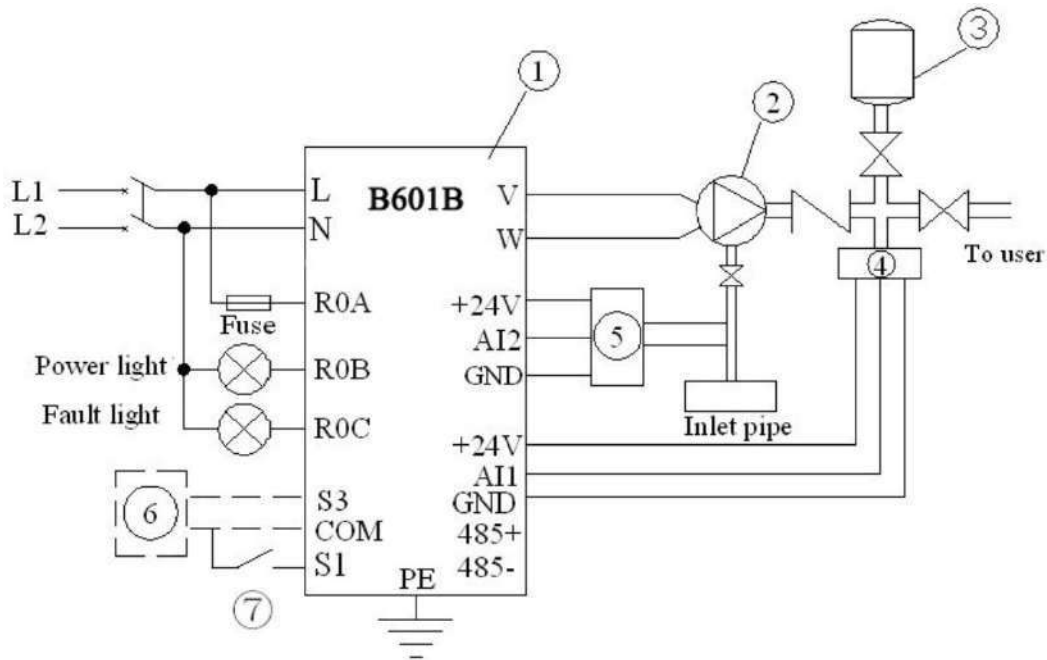

Figure 5-3-1 Terminal Run/Stop Wiring

#### 5.3.2 Operation

Widely used in the occasion of remote run/stop, it's recommended to use a shield twisted pair to wire the external switch. When the external switch of S1-COM turns on pumps run, when it turns off, pumps stop.

### 5.3.3 Settings

According to the application and section 5.1 to set other parameters first, and then set master b05.02=3. Auxiliaries should press run to put it on standby after set it's parameters.

### 5.4 Electric Contact Gauge Water Supply

#### 5.4.1 System Wiring

In diagram: ① B601B intelligent controller; ② Pumps; ③ Air Pressure Tank; ④ Pressure Switch; ⑤ Water Level Switch

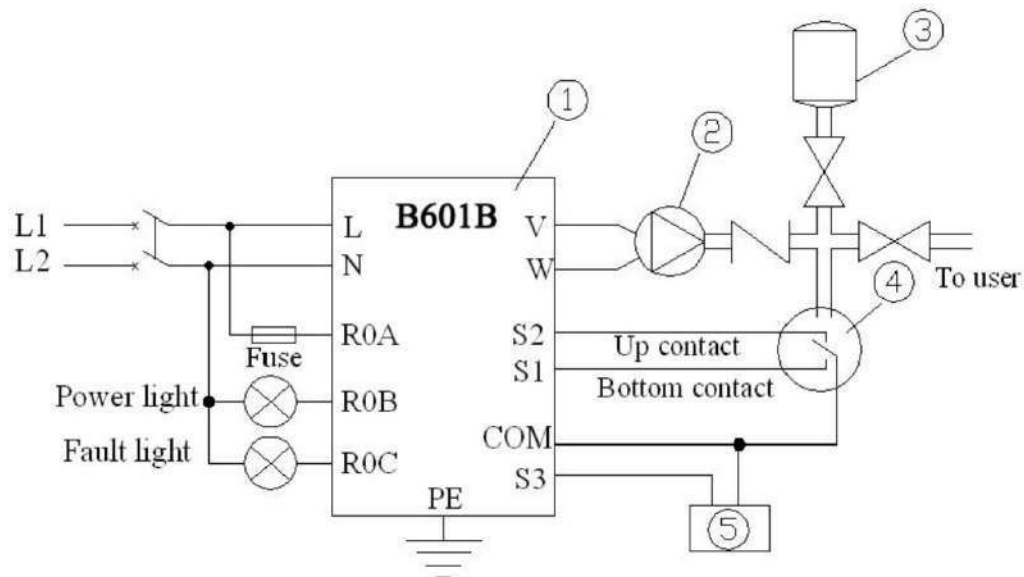

Figure5-4- 1 Electric Contact Pressure Gauge Control Wiring diagram

#### 5.4.2 Setting

Gauge Adjust: This example use the Electric Contact Pressure Gauge instead of the transducer (Wiring refer to section 2.2 **Water Level Switch and Electric Contact Pressure Gauge Wiring**), adjust the gauge's up electric contact and bottom electric contact to the range of need is should be done before running.

For example, want a 0.3MPa water supply, then up contact adjust above scale 0.3MPa (such as at 0.32MPa), bottom electric contact below 0.3MPa (such as at 0.28MPa).

Electric Contact Pressure Gauge Control Setting:

Code	Factory Setting	Recom mend	Description
b00.00	00000	65535	Password of entering parameter groups. Factory set is 65535, it can be modified by b06.09
b02.08	1.0%	0.0%	All Feedback Lost Detecting Value, this application need not pressure detect, set the parameter 0
b08.01~ b08.05			Ensure normal operation, must input parameter according to Nameplate of Motor
b00.02	0	x	Motor rotating direction, set according to the actual motor wiring of spot. Make sure the motor is running in forward direction



### 5.5.3 Relating Parameter Setting

Parameter settings of pumping:

Code	Factory Setting	Recommended	Description
b00.00	00000	65535	Password of entering parameter groups. Factory set is 65535, it can be modified by b06.09
b08.01~ b08.05			Ensure normal operation, must input parameter according to Nameplate of Motor
b00.02	0	x	Motor rotating direction, set according to the actual motor wiring of spot. Make sure the motor is running in forward direction
b02.02	0	1	PID Output Characteristics, set as pumping characteristics
b01.05	10.0	100.0	Set as the range of water level transmitter
b01.00	10.0	100.0	High Water Pressure/Level Alarm Value, set as the alarm water level.
b01.01	0.5	10.0	Low Water Pressure/Level Alarm Value, water level below this value stop pumping
b00.01	3.0	40.0	The Full-frequency pumping water level, above this value full-frequency pumping, below b00.01 and above b01.01 pumping with the setting frequency of b05.07.
Belows need to set based on working conditioning and user's requirement.			
b01.06 b01.08			Water level transmitter calibration, b01.06 use to adjust transducer zero bias. b01.08 use to accordant the display pressure and the gauge pointing. When display smaller than gauge, decrease b01.08; When display bigger than gauge, increase b01.08
b01.02	10	xx	Low Pressure Running Time, set according to actual condition, determine LP detect running time, keep the factory set is ok.
b05.09	00	30	Low Water Level Restart Delay Time, restart with the value setting after a LP delay. Manual restart after low water level need not to change this parameter.

### 5.6 Manual/Auto Control Application

#### 5.6.1 System Wiring

Just refer to the application before and connect an external switch to S2-COM like section 2.2

#### Manual/Auto Control Wiring.

#### 5.6.2 Setting

Related Application and Operations:

Suitable for occasions require full-frequency running pumping, such as construction site manual control water supply, new pipe network water pressure quick promote, etc. Every controller switch on its S2-COM, it will run in full-frequency.

Parameter Setting:

Just take an additional set of b05.02 after the application setting previous finished, set as b05.02 = 2.

## 5.7 Summary

B601B series intelligent water supply controller owns powerful function, to be intelligent water supply, beside previous typical applications, it covers most applications. Such as air conditioning cold water pump, cooling pump constant temperature automatic control, hot water circulation system(include solar energy, heat pump water supply etc.), water treatment system, garden landscape, industry and agriculture production water supply system. User is urged according to spot condition and various functions of B601 to fulfil a good performance water supply.

## 6. FAULT AND TROUBLE SHOOTING

Pump Running Fault and Trouble Shooting:

Fault Code	Fault Type	Reason	Solution
LP	Low water pressure	Sufficient water inflow; Motor rotates in the reverse direction	<ul style="list-style-type: none"> <li>• Check the installation of pressure transmitter</li> <li>• Check the motor's direction of rotation is correct or not</li> <li>• Check the parameter b01.01(setting value too big)</li> <li>• Check the system</li> </ul>
HP	High water pressure	The parameter b01.00 setting value is too small	<ul style="list-style-type: none"> <li>• Check the installation of pressure transmitter</li> <li>• Check the parameter b01.00 (setting value too small)</li> <li>• Check the system</li> </ul>
LL	Low water level	Water level of pool is too low	<ul style="list-style-type: none"> <li>• Check the water system</li> <li>• Check the situation of the control terminal S1</li> </ul>
E022	Sensor fault	Pressure transmitter disconnected; Pressure transmitter short circuit; PID feedback disappears	<ul style="list-style-type: none"> <li>• Check the cable between pressure transmitter and controller;</li> <li>• Check the pressure transmitter</li> <li>• Check PID feedback source</li> </ul>

## 7. MAINTENANCE

### ! WARNING

- Maintenance must be performed according to designated maintenance methods;
- Maintenance must be performed by authorized personnel only;
- After turning off the main circuit power supply, please wait for 10 minutes before maintenance;
- DO NOT directly touch components or devices of PCB board. Otherwise the controller can be damaged by static electricity;
- After maintenance, all screws must be tightened.

### 7.1 Daily Maintenance

In order to prevent the fault and prolong the service life of the controller, user shall daily inspect the controller. The following table indicates the inspection content:

Items to be checked	Means/Methods
Temperature/Humidity	Ambient temperature range shall be 0~40°C, humidity range shall be 20~90%
Oil fog/Dust/Vapor	Ensure there isn't oil fog, dusty and vapor accumulation
Controller	Ensure there isn't abnormal vibration, abnormal heat, abnormal noise and abnormal smell
Fans	Ensure fans are working at good condition, speed and air flow are normal
Power supply	Ensure both the voltage and frequency of power supply are in allowing range
Motor	Ensure there isn't abnormal vibration, abnormal noise, abnormal heat and open-phase problems

### 7.2 Periodic Maintenance

In order to prevent the fault of controller to make it operate smoothly in high-performance for a long time, user must inspect the controller periodically (within half year). The following table indicates the inspection content:

Items to be checked	Inspection content	Means/Methods
Screws	Check whether the screws of control terminals are loose	Tighten them with screwdriver
PCB boards	Dusty, dirt	Clean them with vacuum cleaner
Fans	Abnormal noise, vibration; check whether the fans are used up to 20,000 hours	1. Clean the air ducts with vacuum cleaner; 2. Replace the fans
Electrolytic capacitors	Abnormal color and abnormal smell	Replace the electrolytic capacitors
Cooling plate	Dusty, dirt	Clean them with vacuum cleaner
Power components	Dusty, dirt	
Pump unit	Dusty, sundries; whether the pumps are stuck or running into problems.	1. Clean them with vacuum cleaner; 2. Replace the pump unit

### 7.3 Replacement Of Wearing Parts

Fans and electrolytic capacitors are wearing parts; please make periodic replacement to ensure long term, safety and failure-free operation. The replacement periods are as follows:

- Fan: must be replaced when using up to 20,000 hours;
- Electrolytic capacitor: must be replaced when using up to 30,000~40,000 hours.



## **8. POSTSCRIPT**

The manual provide user spot installing and debugging, for convenient of maintenance and technical personnel spot debugging consult, please keep it carefully after use.

! Prohibit Installation and debugging Parameter being modified by irrelevant personnel. Parameters randomly modified will induce abnormal operation and damaging intelligent controller as well as water supply system, even cause personal injury and safe accidents.

! Please ensure the correct rotating direction which was indicated at the backend of the motor before using. It will cause the situation such as insufficient power, insufficient supply pressure, vibration, noise and so no when the motor is running in the opposite rotating direction.



White International Pty Ltd  
Limited Product Warranties  
TERMS & CONDITIONS

This warranty is given in addition to the consumer guarantees found within the Australian Competition and Consumer Act 2010 (Cth) for goods purchased in Australia and the Consumer Guarantees Act 1993 NZ for goods purchased in New Zealand:

- 1) White International Pty Ltd / White International NZ Ltd (White International) warrant that all products distributed are free from defects in workmanship and materials, for their provided warranty period as indicated on the top or opposite side of this document. Subject to the conditions of the warranty, White International will repair any defective products free of charge at the premises of our authorised service agents throughout Australia and New Zealand if a defect in the product appears during the warranty period. If you believe that you have purchased a defective product and wish to make a claim under this warranty, contact us on our Sales Hotline on 1300 783 601, or send your claim to our postal address or fax line below and we will advise you as to how next to proceed. You will be required to supply a copy of your proof of purchase to make a claim under this warranty.
- 2) This warranty excludes transportation costs to and from White International or its appointed service agents and excludes defects due to non-compliance with installation instructions, neglect or misuse, inadequate protection against the elements, low voltage or use or operation for purposes other than those for which they were designed. For further information regarding the suitability of your intended application contact us on our Sales Hotline on 1300 783 601. If you make an invalid claim under this warranty, the original product will be sent back to you unrepaid.
- 3) This warranty refers only to products sold after the 1st January 2012, and is not transferable to another product type and only applies to the original owner, purchaser or end user, and is in addition to the consumer guarantees found within the Competition and Consumer Act 2010 (Cth) for goods purchased in Australia and the Consumer Guarantees Act 1993 (NZ) for goods purchased in New Zealand.



WHITE INTERNATIONAL PTY LTD  
ABN 48 0001 19380  
52-60 Ashford Ave, MILPERRA NSW 2214  
PO BOX 304, MILPERRA LPO NSW 2214  
Ph: 02 9783 6000 Fax: 02 9783 6001  
Customer Service Hotline: 1300 783 601  
Customer Service Faxline: 02 9783 6003  
EMAIL: Sales Enquiries: info@whiteint.com.au

WHITE INTERNATIONAL NZ LTD  
138 Hugo Johnston Dr PENROSE, AUCKLAND, NZ  
PO BOX 12704, PENROSE, AUCKLAND  
Ph: 09 579 977 Fax: 09 579 7775  
Customer Service Hotline: 0800 509 506  
Customer Service Faxline: 0800 804 344  
EMAIL: General Info Enquiries: sales@whiteint.co.nz



**WHITE** 2 YEAR WARRANTY cont.  
INTERNATIONAL

- 4) Our goods come with guarantees that cannot be excluded under the Australian Consumer Law. You are entitled to a replacement or refund for a major failure and for compensation for any other reasonably foreseeable loss or damage. You are also entitled to have the goods repaired or replaced if the goods fail to be of acceptable quality and the failure does not amount to a major failure.
- 5) To the fullest extent permitted by law, White International excludes its liability for all other conditions or warranties which would or might otherwise be implied at law. To the fullest extent permitted by law, White International's liability under this warranty and any other conditions, guarantees or warranties at law that cannot be excluded, including those in the Competition and Consumer Act 2010 (Cth), is expressly limited to:
  - (a) in the case of products, the replacement of the product or the supply of equivalent product, the payment of the cost of replacing the product or of acquiring an equivalent product or the repair of the product or payment of the cost of having the product repaired, is at the discretion of White International or a 3rd party tribunal elected under the Competition and Consumer Act 2010 (Cth) for goods purchased in Australia and the Consumer Guarantees Act 1993 (NZ) for goods purchased in New Zealand; and
- 6) To the fullest extent permitted by law, this warranty supersedes all other warranties attached to the product or its packaging.
- 7) In the case of services, supplying the services again or the payment of the cost of having the services supplied again, is at the discretion of White International or a 3rd party tribunal elected under the Competition and Consumer Act 2010 (Cth) for goods purchased in Australia and the Consumer Guarantees Act 1993 (NZ) for goods purchased in New Zealand.
- 8) Our warranty commences from the date of purchase of the above mentioned pumps. Proof of purchase is required before consideration under warranty is given. Record your date of purchase in the space below and retain this copy for your records.

Date of Purchase .....

Model Purchased .....



**WHITE**  
INTERNATIONAL

WHITE INTERNATIONAL PTY LTD  
 ABN 48 000 119380  
 52-60 Ashford Ave, MILPERRA NSW 2214  
 PO BOX 304, MILPERRA LPO NSW 2214  
 Ph: 02 9783 6000 Fax: 02 9783 6001  
 Customer Service Hotline: 1300 783 601  
 Customer Service Faxline: 02 9783 6003  
 EMAIL: Sales Enquiries: info@whiteint.com.au

WHITE INTERNATIONAL NZ LTD  
 138 Hugo Johnston Dr PENROSE, AUCKLAND, NZ  
 PO BOX 12704, PENROSE, AUCKLAND  
 Ph: 09 579 977 Fax: 09 579 7775  
 Customer Service Hotline: 0800 509 506  
 Customer Service Faxline: 0800 804 344  
 EMAIL: General Info Enquiries: sales@whiteint.co.nz